

# Quantum Networks for Open Science Workshop

Hilton Hotel, Rockville, MD. September 25-26, 2018  
Hilton Hotel, Rockville, MD

**Workshop Report Presentation to ASCAC**  
March 26, 2019

**Nicholas A. Peters, PhD**  
Senior Staff, Quantum Communications Team Lead  
Quantum Information Science Group  
Oak Ridge National Laboratory

# Quantum Networks for Open Science Workshop

Office of Advanced Scientific Computing Research  
Department of Energy

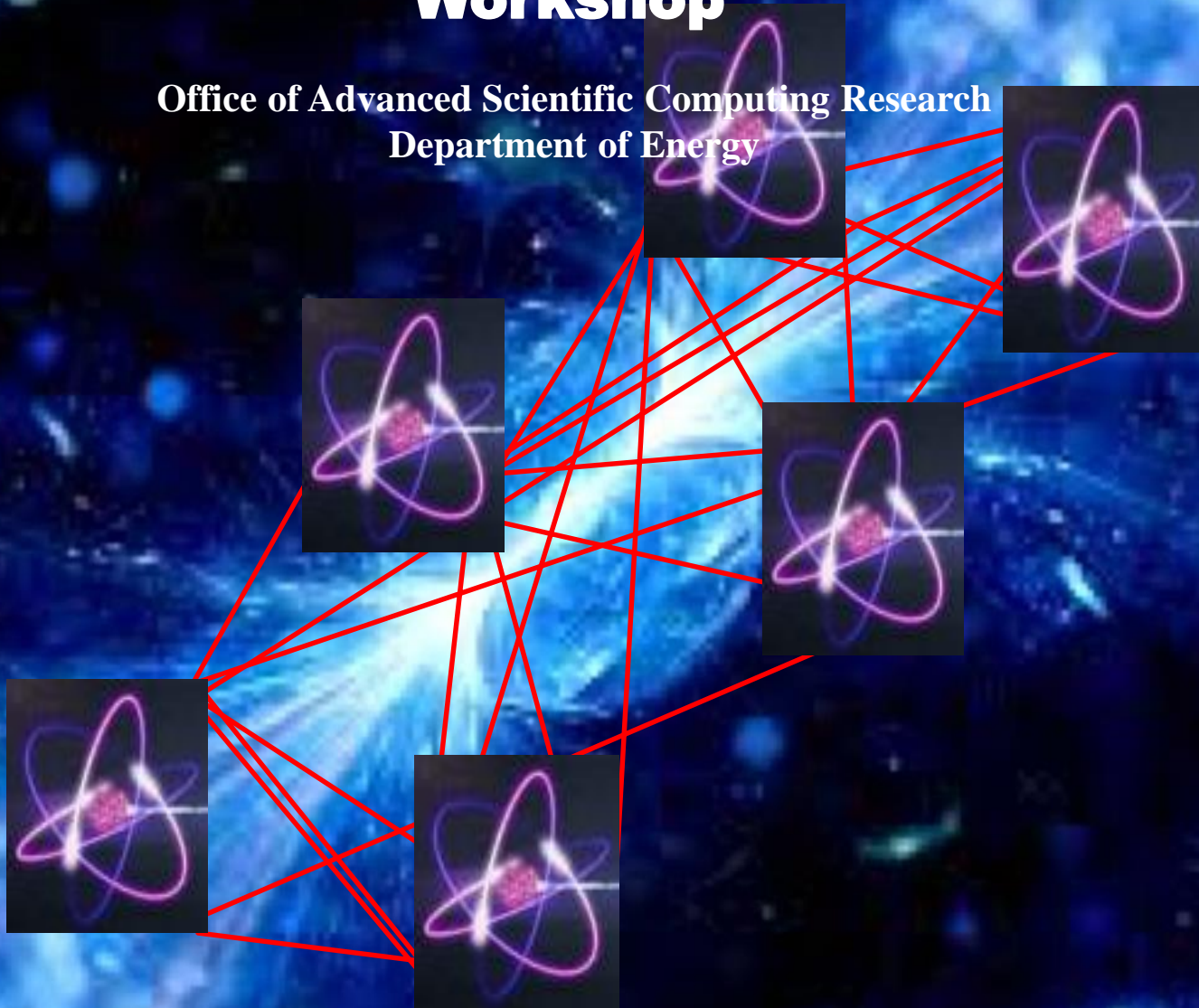

# Workshop Organizing Committee

DOE Point of Contact: Thomas Ndousse-Fetter

Workshop Chairs:

Warren Grice (Qubitekk)

Prem Kumar (Northwestern)

Organizing Committee Members:

Tom Chapuran (Perspecta Labs)

Saikat Guha (University of Arizona)

Scott Hamilton (MIT LL)

Inder Monga (LBL)

Ray Newell (LANL)

Andrei Nomerotski (BNL)

Nicholas Peters (ORNL)

Don Towsley (UMass)

Ben Yoo (UC Davis)

\*Xiaoliang Chen, UC Davis

\*Ben Dixon, MIT LL

\*Alia Long, LANL

Logistical Support:

Jodie Crisp (ORAU)

Julie Webber (ORAU)

# DOE Distributed Science Environment

The Case for Networking (Classical & Quantum Networks)

*Quantum networks are natural extensions of classical networks to support distributed QIS*

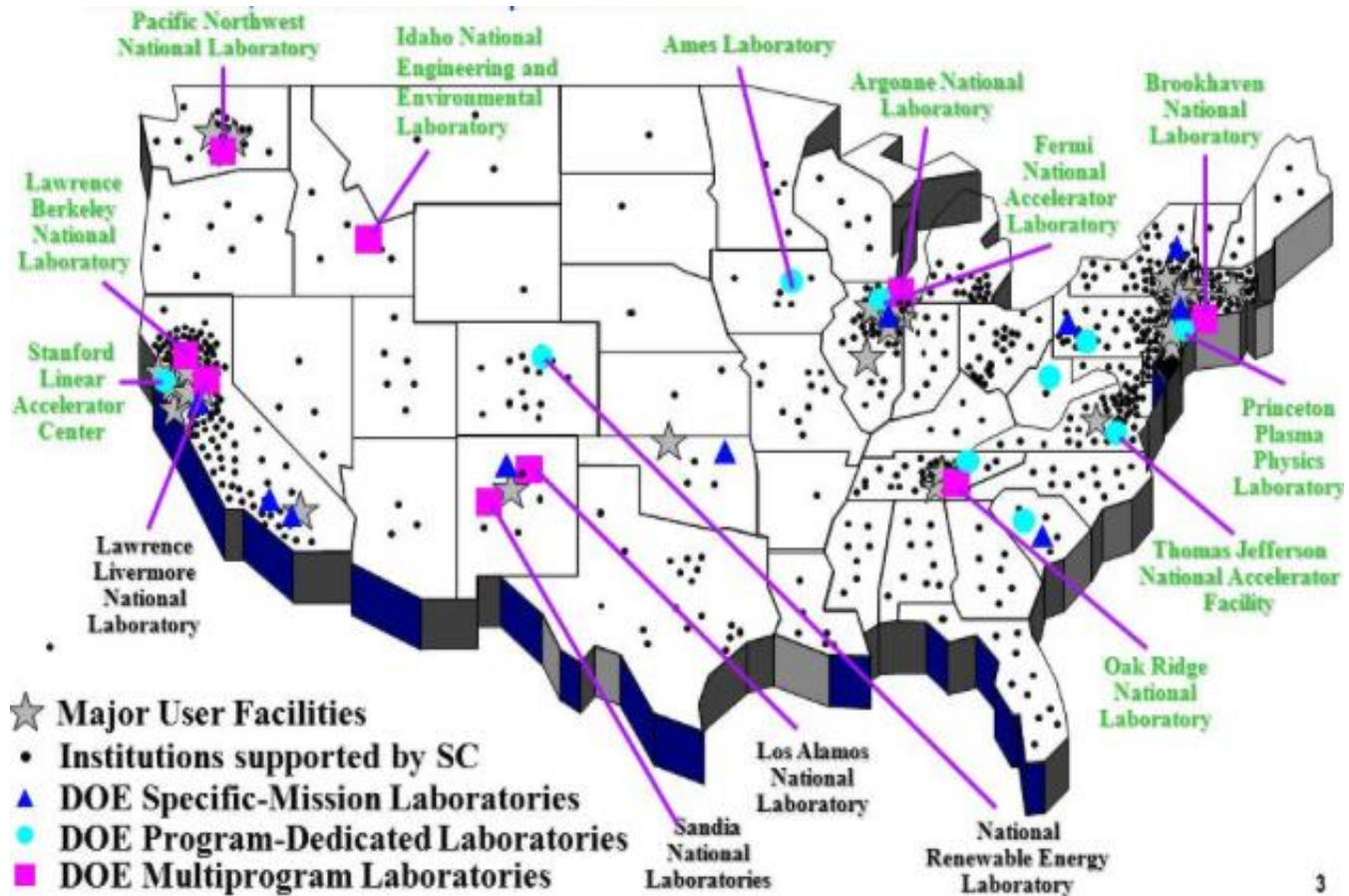



# Quantum Networks: Timing & Critical Infrastructure for Science

## QIS Activities Across the Office of Science (Labs Activities not Shown)

Basic Energy Sciences Roundtable

**Opportunities for Basic Research for  
Next-Generation Quantum Systems**

Fusion Energy Sciences Roundtable on  
**Quantum Information Science**

May

Basic Energy Sciences Roundtable

**Opportunities for Quantum Computing  
in Chemical and Materials Sciences**

**Quantum Sensors at the Intersections  
of Fundamental Science, Quantum  
Information Science & Computing**

Co-Chairs: Swapan Chattopadhyay, Roger Falcone, and Ronald Walsworth  
*Report of the DOE Roundtable held February 25, 2016*

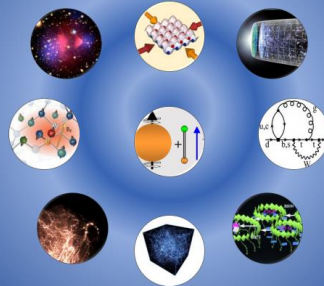

U.S. DEPARTMENT OF  
**ENERGY**  
Office of Science

*Participants and Contributors:*  
David DeMille, Peter Graham, Evelyn Hu, Misha Lukin,  
Mark Kasavich, Nergis Mavalvala, Chris Monroe,  
Holger Mueller, Surjeet Rajendran, Cindy Regal, Mike  
Romalis, David Schuster, Alex Shuskov, Irfan  
Siddiqui, Kartik Srinivasan, Chris Stubbs, Jun Ye

**ASCR Report on a  
Quantum Computing  
Testbed for Science**

ASCR Workshop on Quantum  
Computing for Science

Alán A.  
Stephen



U.S. DEPARTMENT OF  
**ENERGY**

Office of  
Science

Abstract  
This report  
for Science  
technology  
energy m  
workshop  
members  
of quantum  
applied m  
algebra, g  
perspecti  
problems  
to bring o

Quantum  
S



U.S. DEPARTMENT OF  
**ENERGY**

Office of  
Science

**Quantum Computing for Nuclear Physics Workshop**  
November 14<sup>th</sup>, 2017

Advanced Scientific Computing Research  
U.S. Department of Energy  
Ceren.Susut-Bennett@science.doe.gov

# QNOS Timeline

**Summer 2017 – Preliminary explorations**

**12/04/2017 – Quantum Networks for Open Science Roundtable**

**02/05/2018 – Roundtable Report**

- <https://www.ornl.gov/quantumnetworks2018/Quantum-Networks-Roundtable-Report-Final-2018-02-05.pdf>
- Conclusion: *A workshop is needed to further explore the opportunities and challenges in the development of quantum networks for open science.*

**09/25-09/26 2018 – Quantum Network for Open Science Workshop**

**03/12/2019 – Workshop Report Delivered to ASCR**

**06/26/2019 ASCAC Presentation**

# Quantum Networks Roundtable Discussion

## Objectives:

- Assess the state of quantum networks in the commercial, academic, laboratory, and international settings
- Assess the strategic impacts of quantum networks in future scientific infrastructures.

## Summary of Roundtable Recommendations

- A critical area for investment at DOE to support the emerging QIS initiatives
- Convene a workshop to assess DOE needs, workforce, and strategies
- Leverage existing networking technologies in DOE

### Organizers:

**DOE POC:** Thomas Ndousse-Fetter

**Report POCs:** Warren Grice, ORNL /Prem Kumar, Northwestern University

### Attendees

- Jonathan Dubois, LLNL
- Saikat Guha, University of Arizona
- Dan Kilper, University of Arizona
- Paulina Kuo, NIST
- Guifang Li, University of Central Florida
- Lijun Ma, NIST;
- Inder Monga, ESnet/LBL;
- Andrei Nomerotski, BNL
- Nicholas Peters, ORNL
- Oliver Slattery, NIST
- Daniel Soh, SNL
- Xiao Tang, NIST

# QNOS Workshop Charge Letter Summary

“The vision and scope of quantum networking for the QNOS workshop, as articulated in the charge letter to the organizing committee, was to identify the opportunities and challenges for developing scalable quantum networks by transmission of quantum information through optical fiber.”

–QNOS Workshop Report



# Workshop Purpose

## Workshop Goals

- Gather community input
- Organize input
- Generate report

## Key questions

- Why should ASCR be interested in quantum networks?
- What are the key technical challenges that need to be addressed?
- What are the near-term goals?
- What are the long-term goals?

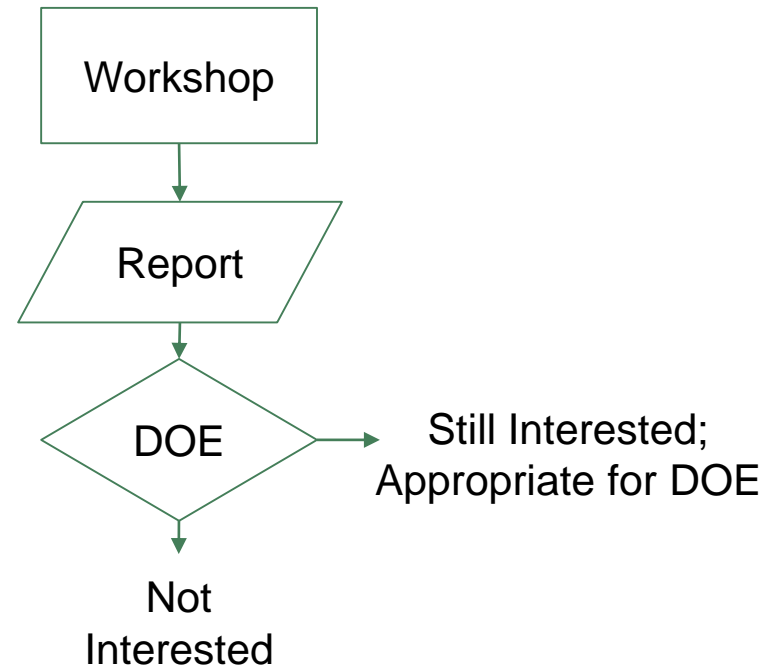

# Workshop Scope

- Discussion scope
  - Quantum network-enabled science applications
  - Hardware and software subsystems, architectures, protocols, and components
  - Quantum network control modeling and management
- Out of scope topics
  - Wireless quantum network technologies
  - Satellite-based quantum technologies
  - Quantum computing materials development

# Workshop Attendees

72 Attendees by Affiliation

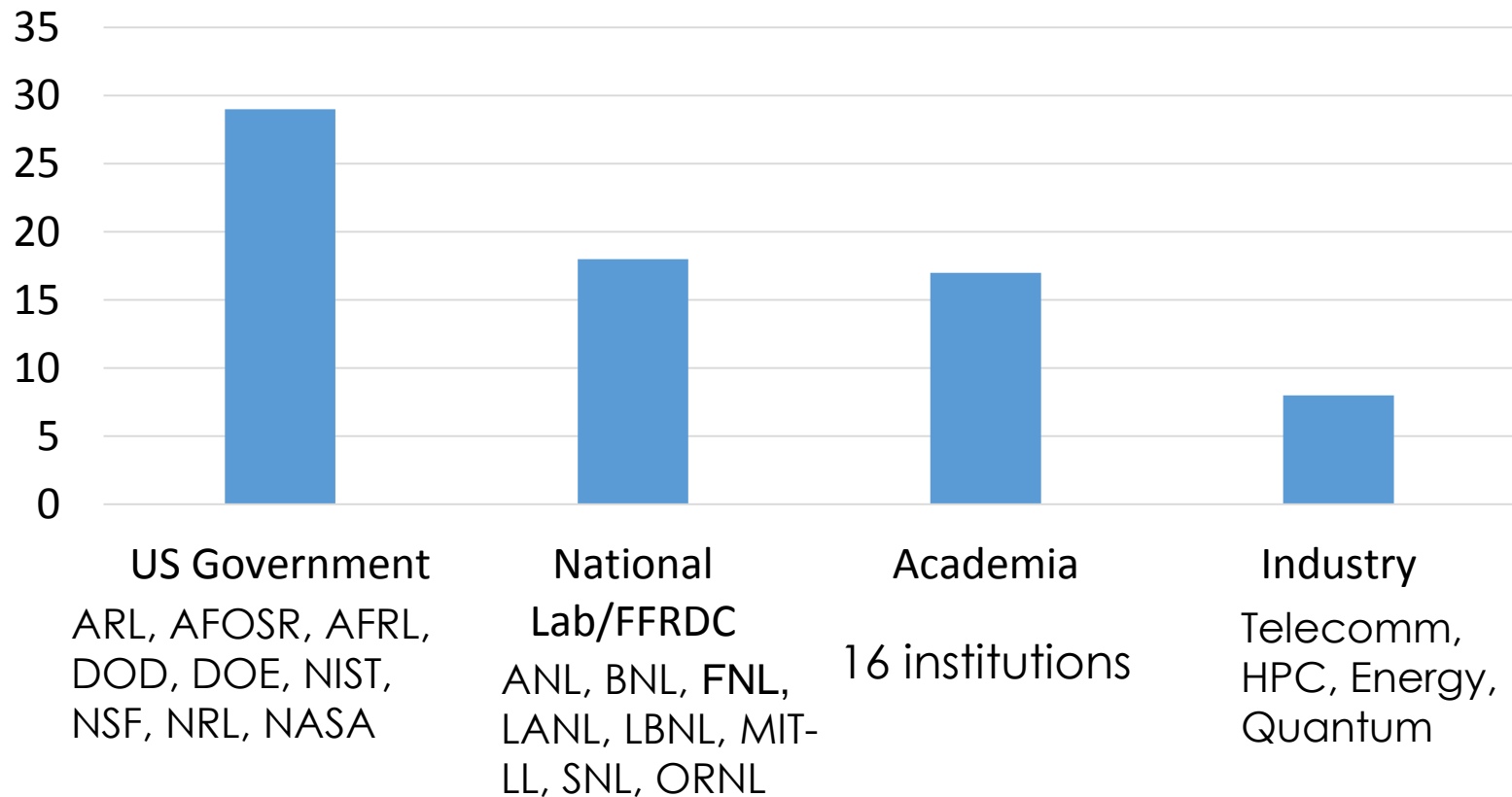

## **Multidisciplinary approach**

- Quantum Physicists
- Classical network researchers (TCP/IP)
- Optical network Engineers/physicists
- QIS application developers
- Domain scientists
- Classical computer scientists
- Network operators

# Workshop Organization

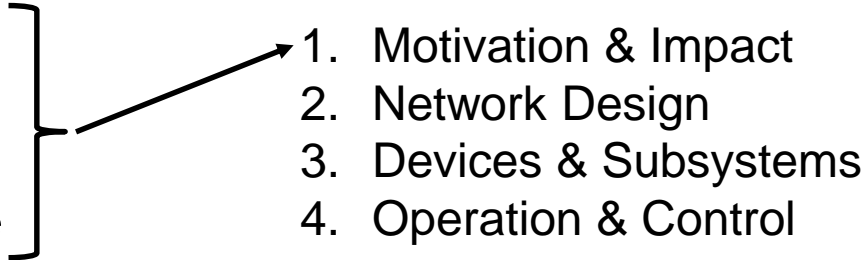
- Introduction, Goals, & Objectives
  - Plenary Talks
  - Introduction talks
  - Breakout Sessions
    - Day one: Mixed Expertise
- 
1. Motivation & Impact
  2. Network Design
  3. Devices & Subsystems
  4. Operation & Control
- Summaries from day one breakouts
  - Cross-cutting Discussion
  - Breakout Groups
    - Focused Expertise to align with 1-4.
    - Collect attendees input; feed into workshop report

# Workshop Report Highlights

- Science applications
- State-of-the-art quantum networks
- Coexistence of quantum and classical signals to leverage ESN
- What needs to be developed



# Motivating Quantum Science Applications

## Breakout Topic 1

### **Discussions Objective:**

- Identify the motivating drivers and science applications to be supported by Quantum Networks
- Computing and communications are interdependent information technologies
- Distributed quantum computing
- Quantum sensors to test for new science (e.g., dark matter)
  - Atomic clocks
  - Phase sensor networks
  - Magnetometers
- Blind quantum computing
- Quantum key distribution/quantum digital signatures

# Attributes of ASCR vision for Quantum Networks

(Beyond QKD Links)

Continental-scale quantum network:

- Universal (transparent) optical quantum networks
- Serve a broad range of distributed QIS applications
- Universal quantum encoding schemes (DV, CV, Hybrid)
- Interworking federal quantum networks
  - Q-LANs in National Laboratories
  - Q-WANs – connecting Q-LANs and Q-MANs
  - Q-internet
- Hybrid Classical/Quantum networking over shared optical transmission systems



# Energy Science Network (ESnet)

(A unique resource to be leveraged)

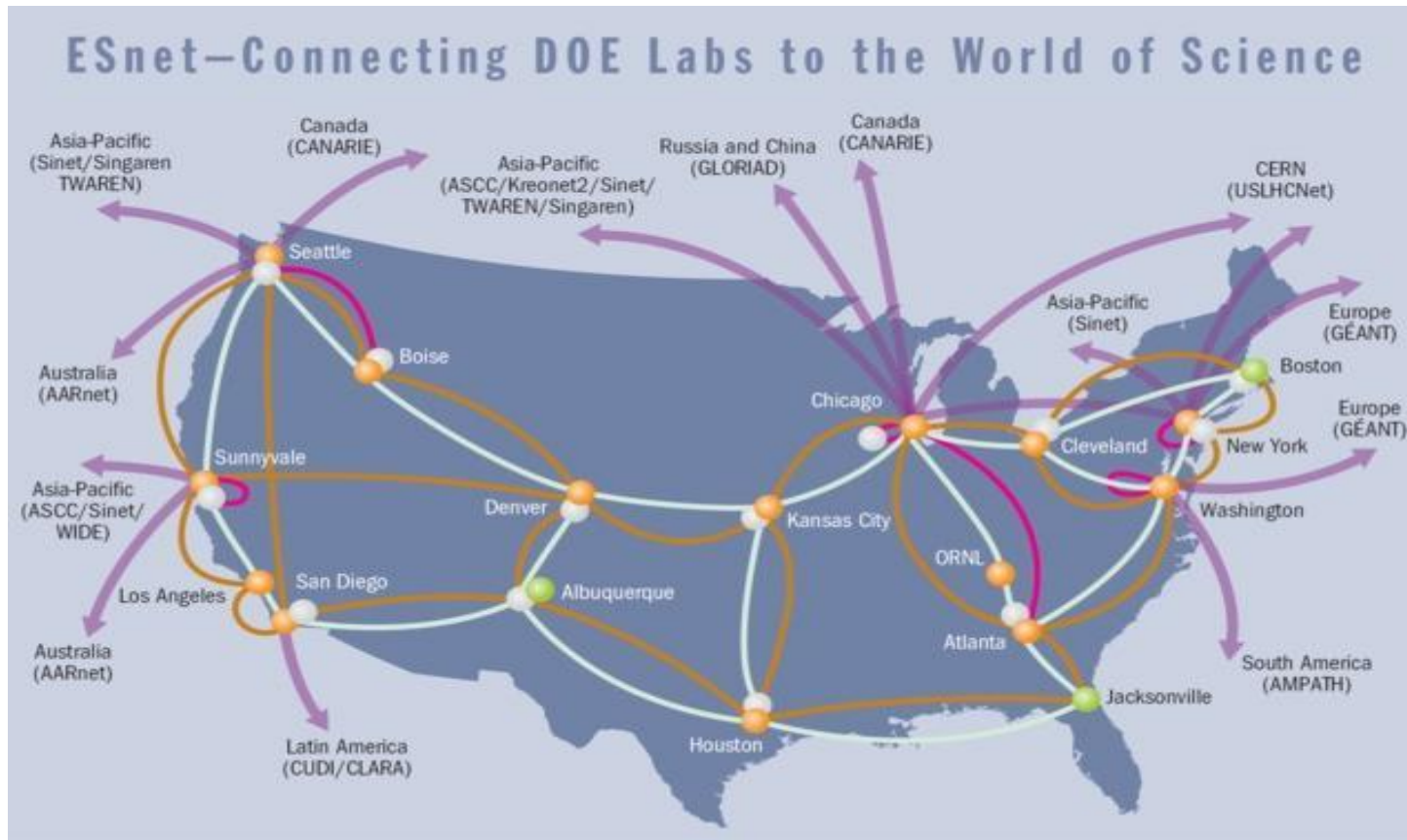

- Fiber optical networks are infrastructure
- It is desirable to leverage DOE's high-performance optical backbone network for quantum as well as classical communications
- Quantum repeaters required to build networks beyond metro scale

# State-of-the Art: Quantum Optical Networking

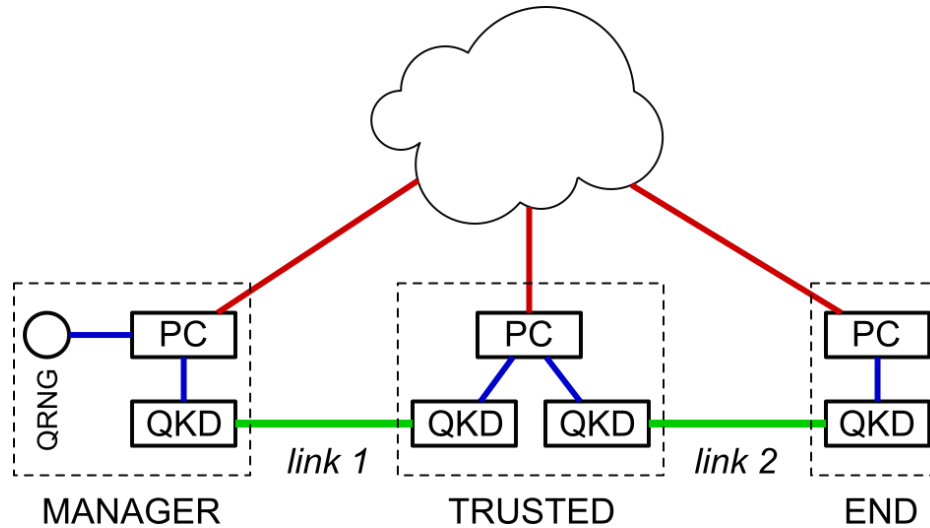

- Mostly focused on Quantum Key Distribution
  - Fundamental rate/loss tradeoff
- Trusted relays are used to scale to longer distances (thousands of km)
  - This solution only suitable for QKD
  - Could perhaps be upgraded later to quantum repeaters
- Rate/loss bound recently exceeded but not scalable:  
<https://arxiv.org/abs/1902.06884>

# Quantum Network Architecture

(Breakout Topic 2 – 1/3)

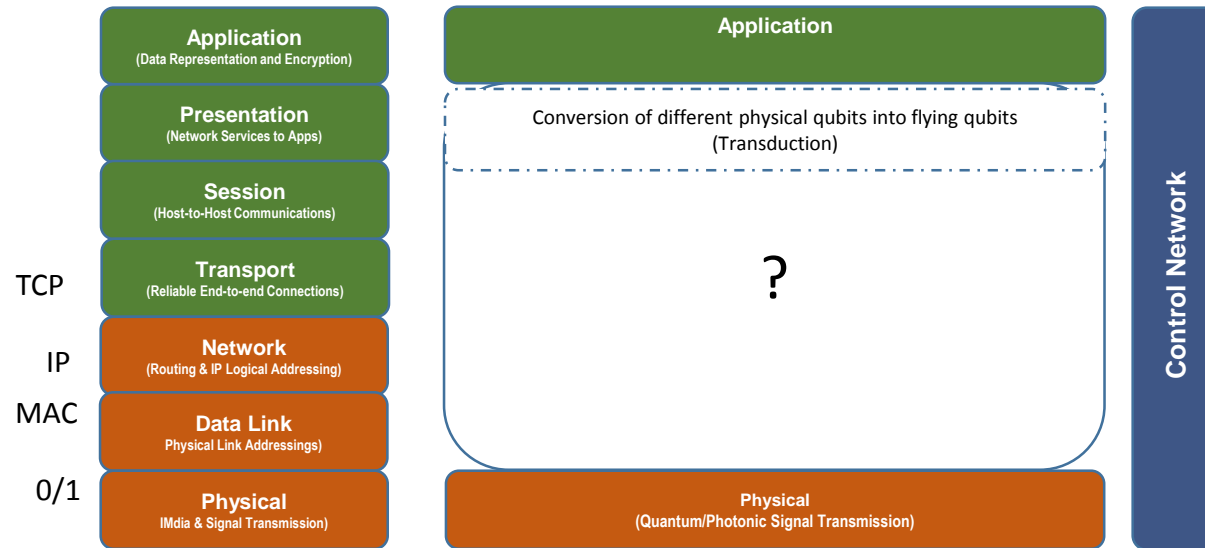

OSI Reference Model

Quantum Network – Reference Model

- Most work so far has been done at the physical layer but not solved yet.
- How does one marry concepts of how computers communicate with the fundamentally different constraints of quantum signals?
  - Latency
  - No cloning
  - No amplification
  - No capability to read routing information on quantum signals
- How does one do performance modeling and simulation?



# Quantum Network Architecture

(Breakout Topic 2 – 2/3)

## Evolution towards transparent quantum networks

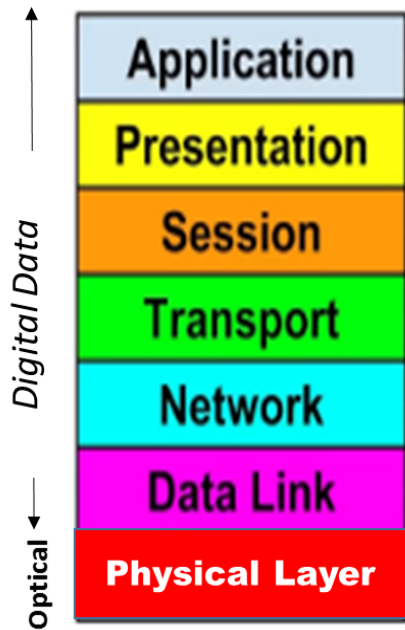

### In the beginning

- IP- Framing
- Store & Forward
- In-band signaling
- Signal regeneration

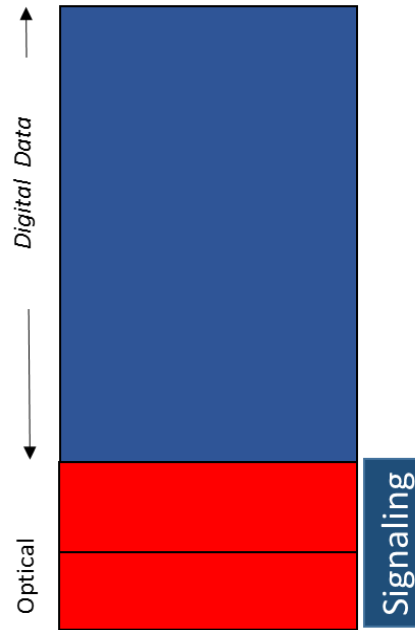

### Current Optical Networks

- IP- Framing/optical encoding
- Store & Forward
- In-band/out-of-band signaling
- 3R Signal regeneration (EDFA)
- E-O-E conversion

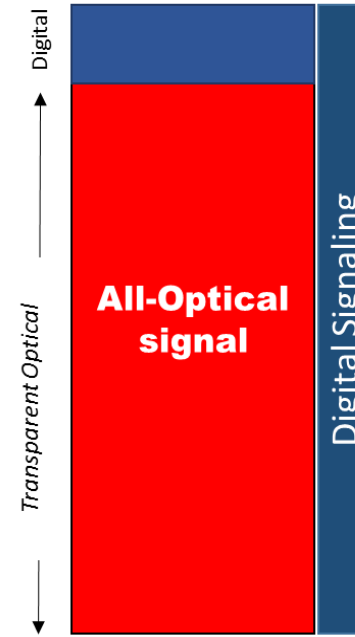

### Transparent Optical Networks

- optical Framing/encoding
- No optical buffers/processor
- Just-in-time out-of-band signaling
- 3R Signal regeneration (EDFA)
- E-O-E conversion

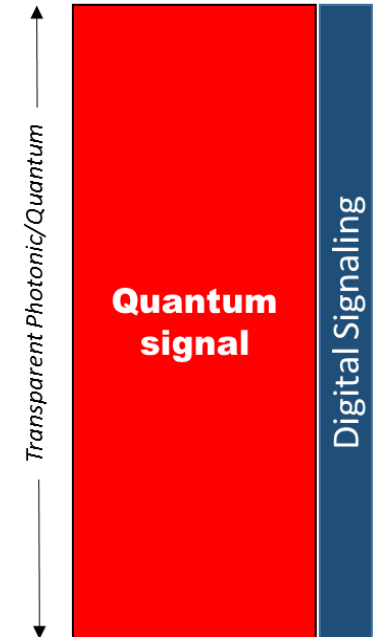

### Transparent Quantum/Photonic

- optical Framing/encoding
- Quantum memory
- Just-in-time out-of-band signaling

## Additional Benefit

- Transparent quantum networks as an enabling technology for all-optical networks

# Quantum Network Architecture

(Breakout Topic 2 – 3/3)

## Evolution towards transparent quantum networks

### Quantum Transparency and encoding formats

- “Quantum transparency” supports transmission of different quantum resources
  - Squeezed states
  - Different forms of entanglement
  - Is it needed for diverse science applications?
- Should one use photonic qubits, qudits, continuous variables, or a hybrid?
- Degree of freedom for encoding not clear, e.g., phase, polarization?

# Optical Spectrum Coexistence for Quantum Networks

(Breakout Topic 2: Network Design)

## Spectrum Management Technology

- WDM
- DWDM
- CWDM
- ...
- FlexGrid

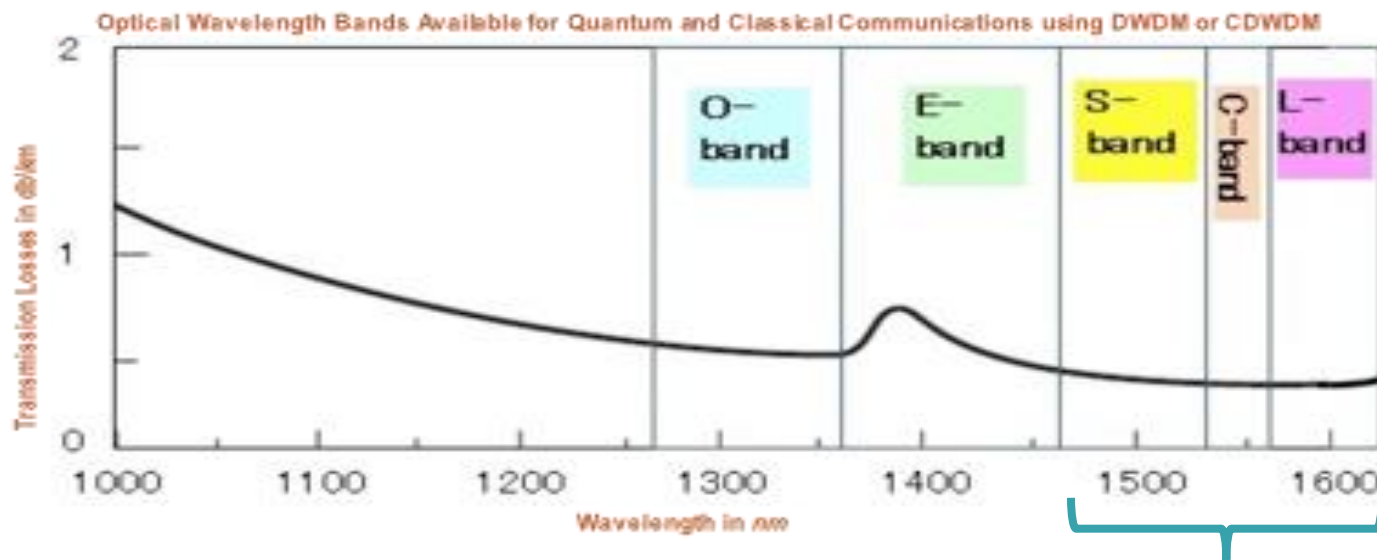

Typical spectrum for classical signals

## Goal:

- Sharing existing Esnet optical fiber infrastructure (ESNet)

## Challenges:

- Classical signals  $\gg$  quantum signals
- Classical signals cause broadband noise
- Even if one had "dark fiber," there is still a need for classical signals for timing, and tuning.

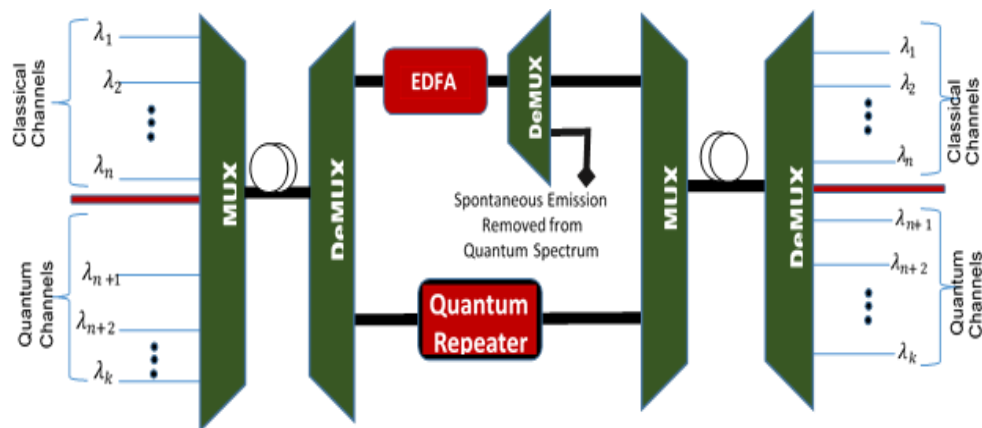

Figure 4: Optical communications fiber link engineered with two wavelength partitions to simultaneously carry photonic quantum states and classical traffic.

# Devices & Subsystems

(Breakout Topic 3: 1/2)

**Objective: Identify the challenges and opportunities for the critical quantum network devices and subsystems.**

- **Transduction devices** – connect different matter qubits to photonic qubits
  - **Quantum frequency conversion** –changes color of photonic qubit without spoiling quantum properties
  - **Single Photon and entangled photon sources**
  - **Quantum Routers** – needed to move beyond point-to-point quantum transmission
  - **Quantum Memories and Buffers** – need to store quantum information
  - **Quantum State Multiplexers/De-multiplexers** - allow aggregation and disaggregation of photonic quantum carriers
  - **Quantum Repeaters** – necessary to extend the current link span beyond 150km
- ❖ For the most part, these are all active research topics.

# Devices & Subsystems

(Breakout Topic 3: 2/2)

## Critical Technology: Quantum Repeaters

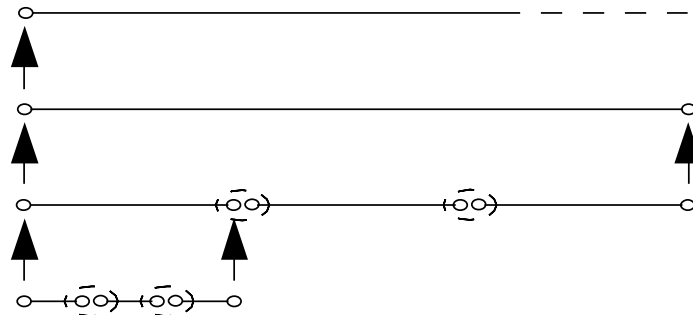
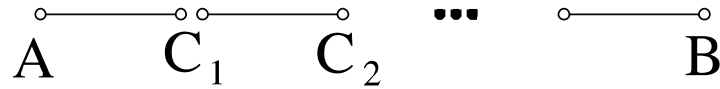

- Not anything like classical regeneration
- Most widely considered: distribute two-qubit entanglement
  - Perform quantum teleportation
- Protect quantum information with quantum error correction
- Needs significant effort
  - Cannot currently do better than direct transmission
  - Feasibility in coexistence network is unclear



# Quantum Network Operations & Management

## (Breakout Topic 4)

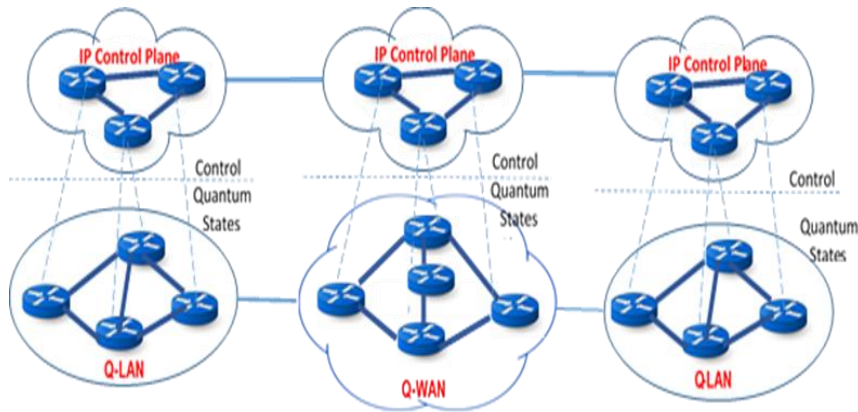

Figure 5: End-to-End Transparent Optical Networks with Digital Control Plane

### Just-in-Time (out-of-Band Control)

- IP-based control networks
- Multi-domain inter-networking
- Build on MPLS/GMPLS

## Challenges

- Simulation of distributed quantum resources will be more difficult than classical bits. Not clear if current approaches apply.
- Extracting the critical knowledge for operation and control is a complex measurement problem
- It is not clear how to develop a unified control plane network for shared classical/quantum networks
- Quantum state preservation and synchronization

## Opportunities

Quantum network capabilities could enhance control plane security

## Collaborations

- US Government missions are diverse, and seem likely to develop complementary quantum communications networking technologies.
- National Institute of Standards and Technology (NIST)
  - Quantum network metrology
  - Standards efforts are critical to ensure interoperability of components and protocols
- The National Aeronautics and Space Administration's (NASA) efforts on space-based quantum communications complements fiber
- The Department of Defense's research labs are developing quantum technologies, which may be useful for science applications.
- Industry, Academia, National Laboratory collaborations across multiple education levels
- Collaboration will greatly strengthen the impact of developed quantum networks.

# Path Forward

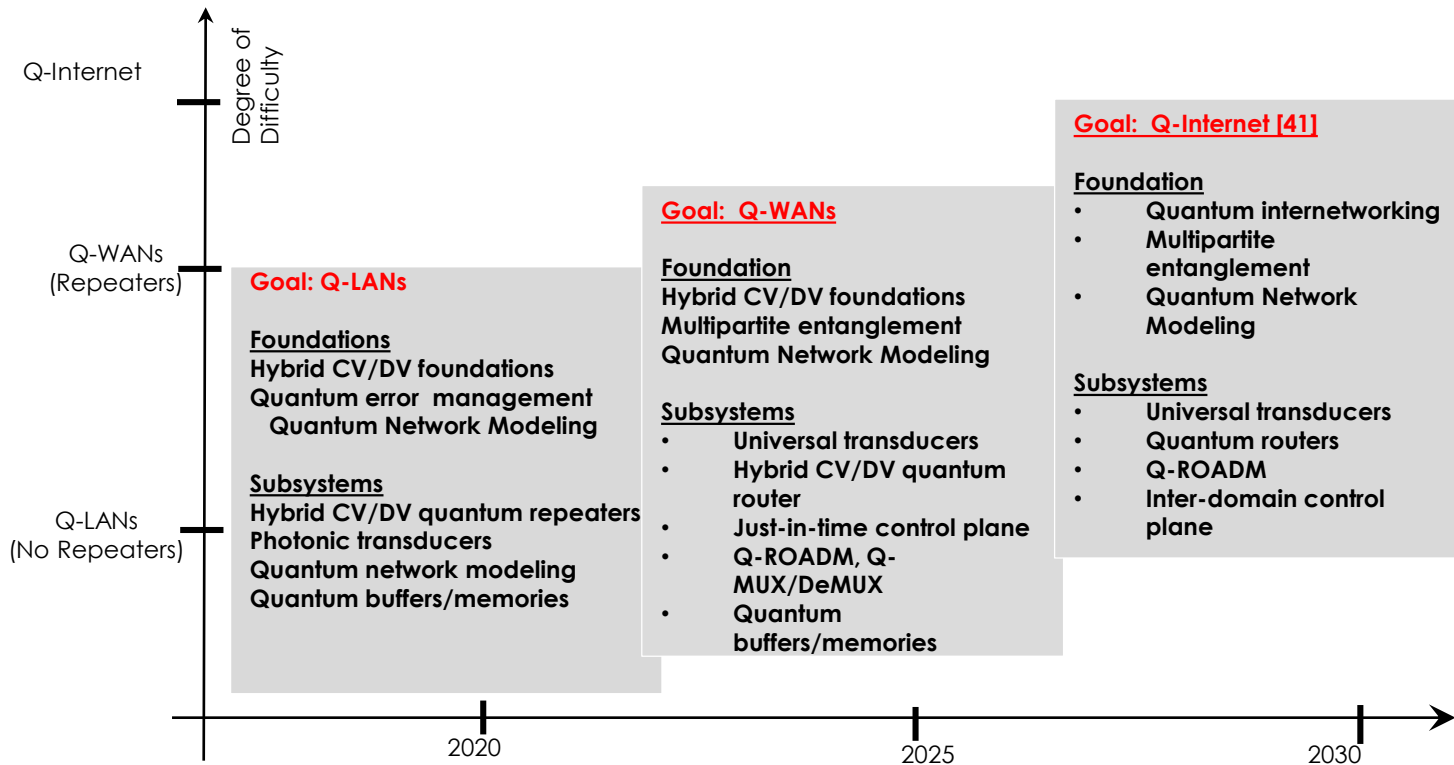

Transparent optical Quantum networks evolution in the open science environment

- Quantum networking is a nascent interdisciplinary field
- Quantum physics, telecommunications engineering, optical communications, computer science, cyber security, and domain science have not traditionally worked together and need to do so.
- Such collaboration is needed to solve a problem as complex as developing a general-purpose quantum network.

# Report Format

## Technical areas

- Working Group discussion
- Short-Term Challenges and Opportunities
- Long-Term Challenges and Opportunities

## Summary Discussion

Path Forward – three categories of efforts

- Repeater-less Q-LANs and Q-MAN
  - Q-WANs
    - Q-Internet

*The main objective was to establish a high-level vision of a continental-scale transparent, hybrid quantum network ecosystem for science*

*Future workshops will be needed to develop the detailed design challenges of various subsystems and components.*

Questions?

# Workshop Attendees

First Name	Last Name	Affiliation
Scott	Alexander	Perspecta Labs
Yuri	Alexeev	Argonne National Laboratory
Fil	Bartoli	ENG/ECCS Division Director, NSF
Joe	Britton	Army Research Lab
Robert	Broberg	Cisco Systems
Michael	Brodsky	US Army Research Lab
Benjamin	Brown	DOE SC ASCR
Ivan	Burenkov	Joint Quantum Institute at NIST and UMD
Stephen	Bush	GE Global Research
Mark	Byrd	Southern Illinois University
Ryan	Camacho	Brigham Young University
Jean-Luc	Cambier	Air Force of Scientific Research
Thomas	Chapuran	Perspecta Labs
Lali	Chatterjee	DOE HEP
Xiaoliang	Chen	UC Davis
Tatjana	Curcic	AFOSR
Dominique	Dagenais	National Science Foundation
Cees	De Laat	University of Amsterdam
Jonathan	Dowling	Louisiana State University
Yao-Lung (Leo)	Fang	Brookhaven National Lab
Eden	Figuroa	Stony Brook University
Hal	Finkel	Argonne National Laboratory
Warren	Grice	Qubitekk
Saikat	Guha	University of Arizona
Scott	Hamilton	MIT Lincoln Laboratory
James	Harrington	HRL Laboratories
Kurt	Jacobs	US Army Research Laboratory
Eric	Johnson	National Science Foundation
Gregory	Kanter	NuCrypt
Rajkumar	Kettimuthu	Argonne National Laboratory
Hari	Krovi	Raytheon BBN Technologies
Prem	Kumar	Northwestern University
Paul	Kwiat	UIUC
Nikolai	Lauk	Caltech
Randall	Laviolette	ASCR
Norbert	Linke	Joint Quantum Institute, University Maryland
Alia	Long	Los Alamos National Laboratory
Joseph	Lukens	Oak Ridge National Laboratory
Joseph	Lykken	Fermi National Accelerator Laboratory
Hideo	Mabuchi	Stanford University

Sonia	McCarthy	DOE ASCR
Grace	Metcalfe	
Bogdan	Mihaila	National Science Foundation
Alan	Mink	NIST
Rich	Mirin	NIST
Indermohan	Monga	Lawrence Berkeley National Laboratory
Raymond	Newell	Los Alamos National Laboratory
Tristan	Nguyen	Air Force of Scientific Research
Andrei	Nomerotski	BNL
Lucy	Nowell	DOE Office of Science
Nicholas	Peters	Oak Ridge National Laboratory
Robinson	Pino	DOE Office of Science
Bing	Qi	ORNL
Gulshan	Rai	Department of Energy, Office of Nuclear Physics
Nageswara	Rao	Oak Ridge National Laboratory
Akbar	Sayeed	National Science Foundation
Thomas	Schenkel	Lawrence Berkeley National Laboratory
Kevin	Silverman	NIST-Boulder
A. Matthew	Smith	Air Force Research Laboratory
Keith	Snail	Army Research Laboratory
Daniel	Soh	Sandia National Labs
Martin	Suchara	Argonne National Laboratory
Ceren	Susut	DOE/ASCR
Leandros	Tassiulas	Yale University
Donald	Towsley	UMass
Brian	Williams	Oak Ridge National Laboratory
Alan	Willner	Univ. of Southern California
Dantong	Yu	New Jersey Institute of Technology